

1N4448WS

Silicon Epitaxial Planar Switching Diode

Fast Switching Diode

PINNING

PIN	DESCRIPTION
1	Cathode
2	Anode

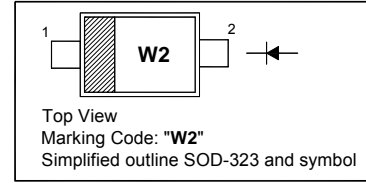

Absolute Maximum Ratings ($T_a = 25^\circ\text{C}$)

Parameter	Symbol	Value	Unit
Peak Reverse Voltage	V_{RM}	100	V
Reverse Voltage	V_R	80	V
Average Rectified Forward Current	$I_{F(AV)}$	150	mA
Forward Continuous Current	I_{FM}	300	mA
Non-Repetitive Peak Forward Surge Current (at $t = 1 \mu\text{s}$)	I_{FSM}	0.5	A
Power Dissipation	P_d	200	mW
Junction Temperature	T_j	150	$^\circ\text{C}$
Storage Temperature Range	T_{stg}	- 65 to + 150	$^\circ\text{C}$

Characteristics at $T_a = 25^\circ\text{C}$

Parameter	Symbol	Min.	Max.	Unit
Forward Voltage at $I_F = 5 \text{ mA}$ at $I_F = 10 \text{ mA}$ at $I_F = 100 \text{ mA}$ at $I_F = 150 \text{ mA}$	V_F	0.62 - - -	0.72 0.855 1 1.25	V
Reverse Leakage Current at $V_R = 80 \text{ V}$ at $V_R = 20 \text{ V}$ at $V_R = 75 \text{ V}, T_J = 150^\circ\text{C}$ at $V_R = 25 \text{ V}, T_J = 150^\circ\text{C}$	I_R	- - - -	100 25 50 30	nA nA μA μA
Reverse Breakdown Voltage at $I_R = 100 \mu\text{A}$	$V_{(BR)R}$	80	-	V
Total Capacitance at $V_R = 0.5 \text{ V}, f = 1 \text{ MHz}$	C_{tot}	-	4	pF
Reverse Recovery Time at $I_F = I_R = 10 \text{ mA}, I_{tr} = 0.1 \times I_R, R_L = 100 \Omega$	t_{rr}	-	4	ns

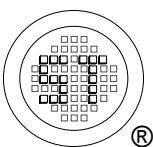

SEMTECH ELECTRONICS LTD.
Subsidiary of Sino-Tech International (BVI) Limited



Dated : 15/06/2009

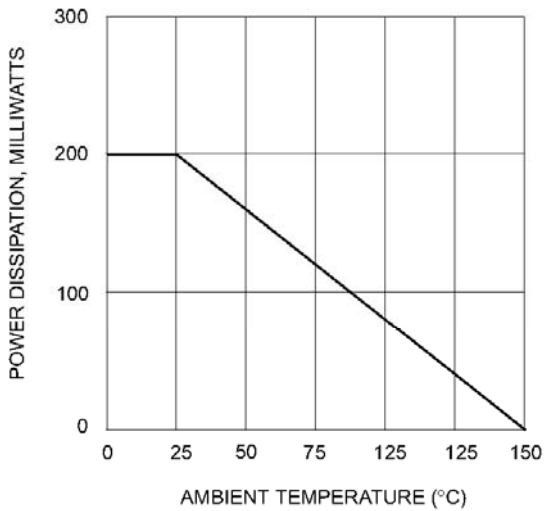

Fig. 1 Forward Current Derating Curve

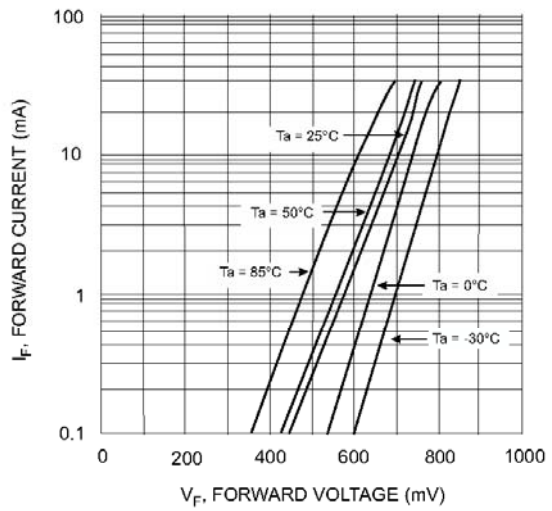

Fig. 2 Typical Forward Characteristics

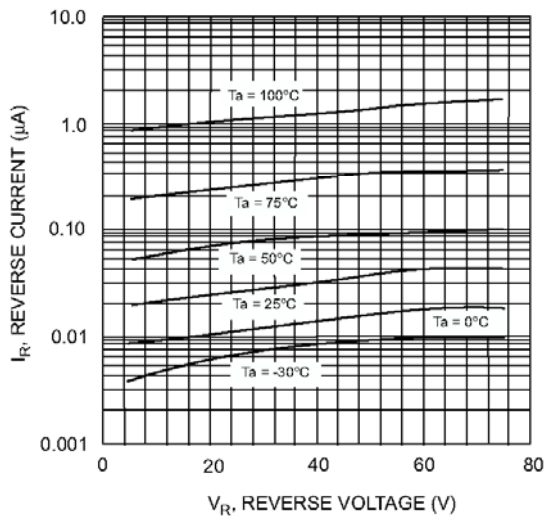

Fig. 3 Typical Reverse Characteristics

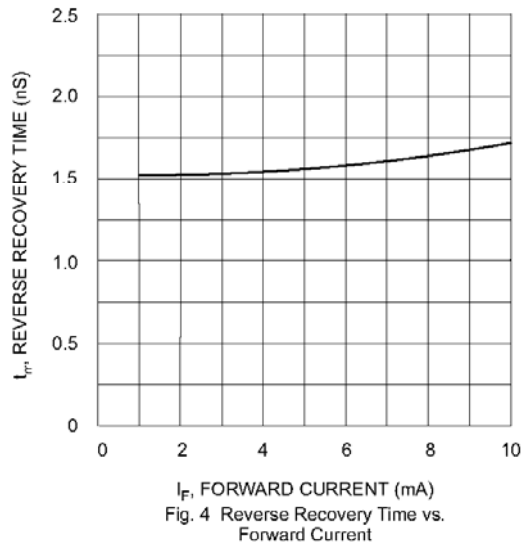
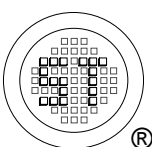

Fig. 4 Reverse Recovery Time vs. Forward Current



SEMTECH ELECTRONICS LTD.
 Subsidiary of Sino-Tech International (BVI) Limited



1N4448WS

PACKAGE OUTLINE

Plastic surface mounted package; 2 leads

SOD-323

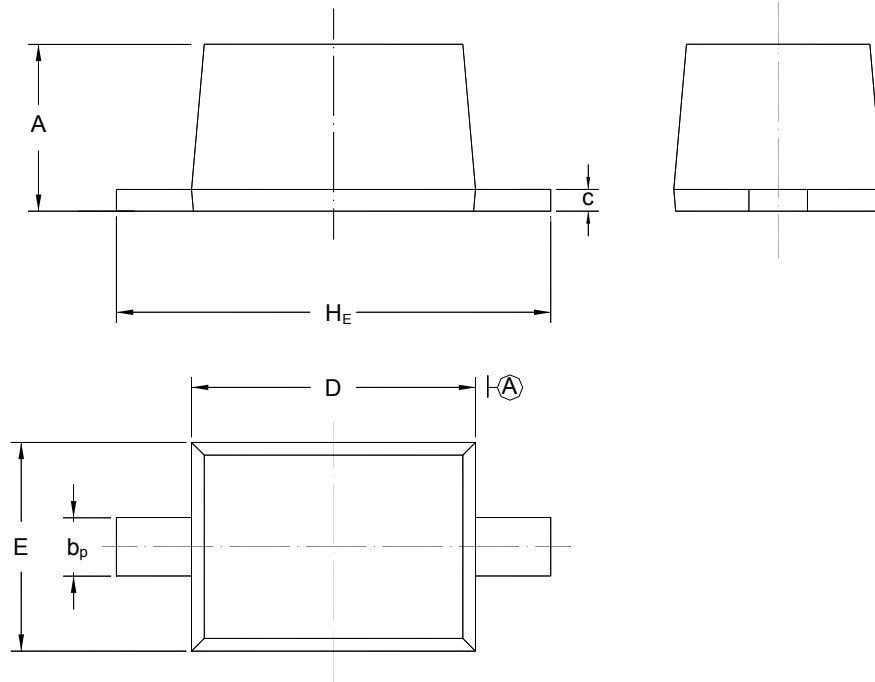

UNIT	A	b _p	C	D	E	H _E
mm	1.10 0.80	0.40 0.25	0.15 0.10	1.80 1.60	1.35 1.15	2.80 2.30

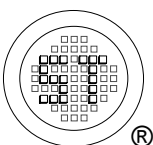

SEMTECH ELECTRONICS LTD.
Subsidiary of Sino-Tech International (BVI) Limited



Dated : 15/06/2009